

80mΩ, 500mA/1.1A High-Side Power Switches with Flag

General Description

The RT9702 and RT9702A are cost-effective, low voltage, single N-Channel MOSFET high-side power switches, optimized for self-powered and bus-powered Universal Serial Bus (USB) applications. The RT9702/A equipped with a charge pump circuitry to drive the internal MOSFET switch; the switch's low $R_{DS(ON)}$, 80mΩ, meets USB voltage drop requirements; and a flag output is available to indicate fault conditions to the local USB controller.

Additional features include soft-start to limit inrush current during plug-in, thermal shutdown to prevent catastrophic switch failure from high-current loads, under-voltage lockout (UVLO) to ensure that the device remains off unless there is a valid input voltage present, fault current is limited to typically 800mA for RT9702 in single port and 1.5A for RT9702A in dual ports in accordance with the USB power requirements, lower quiescent current as 25μA making this device ideal for portable battery-operated equipment.

The RT9702/A is available in SOT-25 package requiring minimum board space and smallest components.

Ordering Information

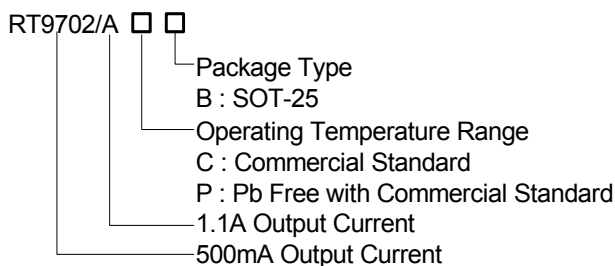

Marking Information

For marking information, contact our sales representative directly or through a RichTek distributor located in your area, otherwise visit our website for detail.

Features

- Compliant to USB Specifications
- Built-In (Typically 80mΩ) N-Channel MOSFET
- Output Can Be Forced Higher Than Input (Off-State)
- Low Supply Current:
 - 25μA Typical at Switch On State
 - 1μA Typical at Switch Off State
- Guaranteed 500mA/RT9702 and 1.1A/RT9702A Continuous Load Current
- Wide Input Voltage Ranges: 2V to 5.5V
- Open-Drain Fault Flag Output
- Hot Plug-In Application (Soft-Start)
- 1.7V Typical Under-Voltage Lockout (UVLO)
- Current Limiting Protection
- Thermal Shutdown Protection
- Reverse Current Flow Blocking (no body diode)
- Smallest SOT-25 Package Minimizes Board Space
- UL Approved—E219878

Applications

- USB Bus/Self Powered Hubs
- USB Peripherals
- ACPI Power Distribution
- PC Card Hot Swap
- Notebook, Motherboard PCs
- Battery-Powered Equipment
- Hot-Plug Power Supplies
- Battery-Charger Circuits

Pin Configurations

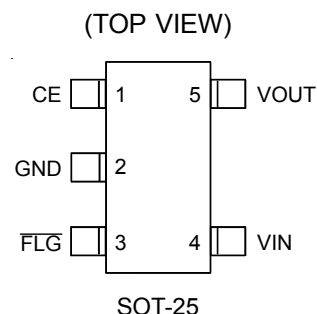

Typical Application Circuit

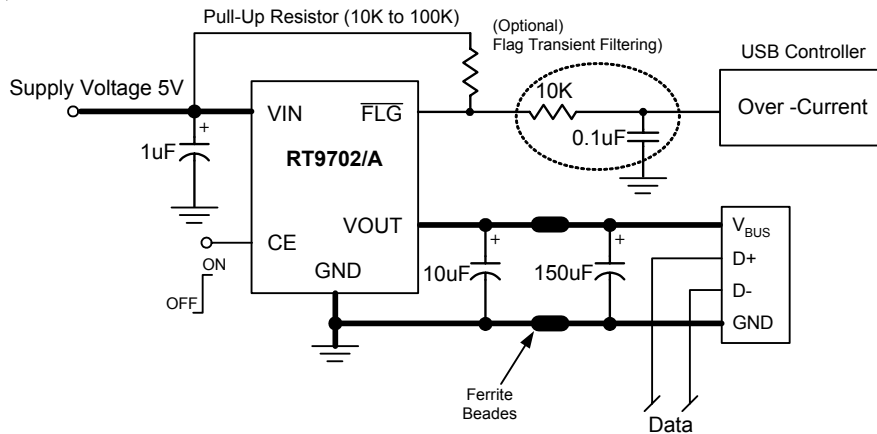

Note: A low-ESR 150 μ F aluminum electrolytic or tantalum between V_{OUT} and GND is strongly recommended to meet the 330mV maximum droop requirement in the hub V_{BUS}. (see Application Information Section for further details)

Functional Pin Description

| Pin Name | Pin Function |
|----------|------------------------------|
| VIN | Supply Input |
| VOUT | Switch Output |
| GND | Common Ground |
| CE | Chip Enable Control Input |
| FLG | Open-Drain Fault Flag Output |

Function Block Diagram

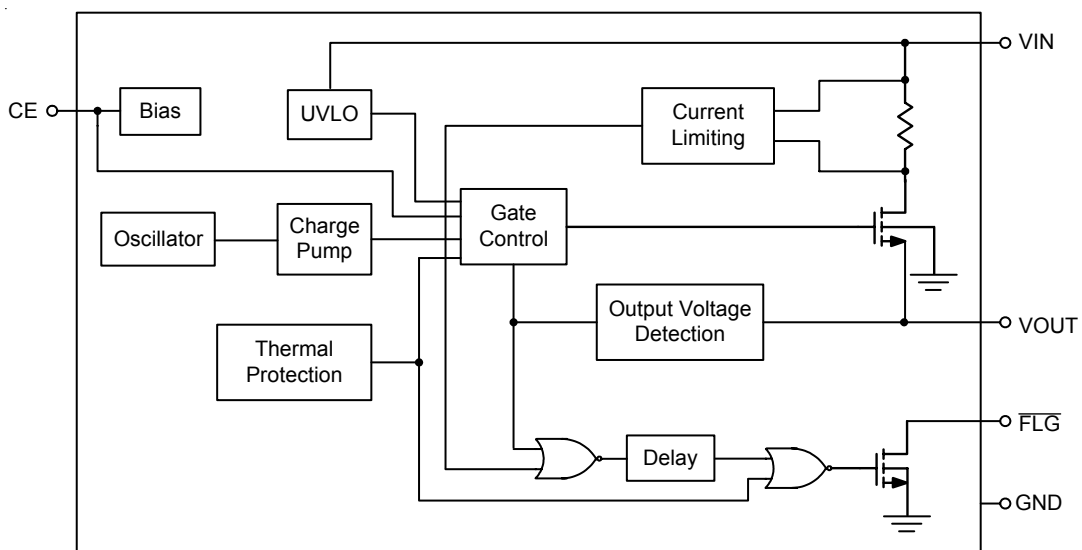

Test Circuits

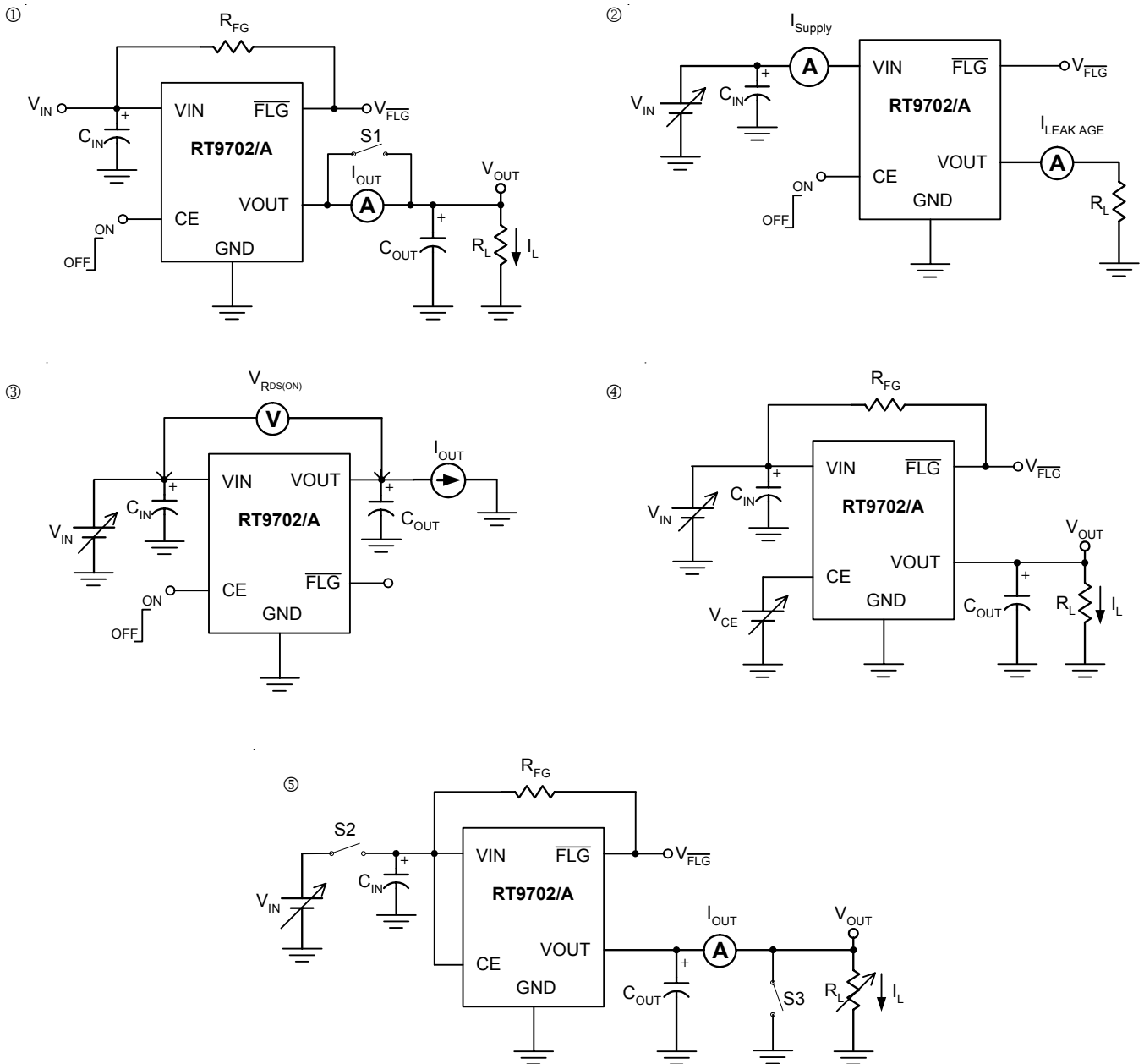

Note: Above test circuits reflected the graphs shown on “Typical Operating Characteristics ” are as follows:

- ①—Turn-On Rising & Falling Time vs. Temperature, Turn-On & Off Response, Flag Response
- ②—Supply Current vs. Input Voltage & Temperature, Switch Off Supply Current vs. Temperature, Turn-Off Leakage Current vs. Temperature
- ③—On-Resistance vs. Input Voltage & Temperature
- ④—CE Threshold Voltage vs. Input Voltage & Temperature, Flag Delay Time vs. Input Voltage & Temperature, UVLO Threshold vs. Temperature, UVLO at Rising & Falling
- ⑤—Current Limit vs. Input Voltage/Temperature, Short Circuit Current Response, Short Circuit Current vs. Temperature, Inrush Current Response, Soft-start Response, Ramped Load Response, Current Limit Transient Response, Thermal Shutdown Response

Absolute Maximum Ratings (Note 1)

- Supply Voltage ----- 6.5V
- Chip Enable Input Voltage ----- -0.3V to 6.5V
- Flag Voltage ----- 6.5V
- Power Dissipation, $P_D @ T_A = 25^\circ C$
 SOT-25 ----- 0.25W
- Package Thermal Resistance
 SOT-25, θ_{JA} ----- 250°C/W
- Junction Temperature ----- 150°C
- Lead Temperature (Soldering, 10 sec.) ----- 260°C
- Storage Temperature Range ----- -65°C to 150°C
- ESD Susceptibility (Note 2)
 HBM (Human Body Mode) ----- 8kV
 MM (Machine Mode) ----- 800V

Recommended Operating Conditions (Note 3)

- Supply Input Voltage ----- 2V to 5.5V
- Chip Enable Input Voltage ----- 0V to 5.5V
- Junction Temperature Range ----- -20°C to 100°C

Electrical Characteristics

($V_{IN} = 5V, C_{IN} = C_{OUT} = 1\mu F, T_A = 25^\circ C$, unless otherwise specified)

| Parameter | | Symbol | Test Conditions | Min | Typ | Max | Units |
|---------------------------------|--------------------|----------------|---|-----|------|-----|-------|
| Switch On Resistance | RT9702 | $R_{DS(ON)}$ | $I_{OUT} = 500mA$ | -- | 80 | 100 | mΩ |
| | RT9702A | | $I_{OUT} = 1.1A$ | | | | |
| Supply Current | | I_{SW_ON} | switch on, $V_{OUT} = Open$ | -- | 25 | 45 | μA |
| | | I_{SW_OFF} | switch off, $V_{OUT} = Open$ | -- | 0.1 | 1 | |
| CE Threshold | Logic-Low Voltage | V_{IL} | $V_{IN} = 2V$ to 5.5V, switch off | -- | -- | 0.8 | V |
| | Logic-High Voltage | V_{IH} | $V_{IN} = 2V$ to 5.5V, switch on | 2.0 | -- | -- | V |
| CE Input Current | | I_{CE} | $V_{CE} = 0V$ to 5.5V | -- | 0.01 | -- | μA |
| Output Leakage Current | | $I_{LEAKAGE}$ | $V_{CE} = 0V, R_{LOAD} = 0\Omega$ | -- | 0.5 | 10 | μA |
| Output Turn-On Rise Time | | T_{ON_RISE} | 10% to 90% of V_{OUT} rising | -- | 400 | -- | μs |
| Current Limit | RT9702 | I_{LIM} | $R_{LOAD} = 1\Omega$ | 0.5 | 0.8 | 1.1 | A |
| | RT9702A | | | 1.1 | 1.5 | 2.0 | |
| Short Circuit Fold-Back Current | RT9702 | I_{SC_FB} | $V_{OUT} = 0V$, measured prior to thermal shutdown | -- | 0.8 | -- | A |
| | RT9702A | | | -- | 1.0 | -- | |
| FLAG Output Resistance | | R_{FLG} | $I_{SINK} = 1mA$ | -- | 20 | 400 | Ω |
| FLAG Off Current | | I_{FLG_OFF} | $V_{FLG} = 5V$ | -- | 0.01 | 1 | μA |
| FLAG Delay Time (Note 4) | | t_D | From fault condition to \overline{FLG} assertion | 2 | 10 | 15 | ms |

To be continued

| Parameter | Symbol | Test Conditions | Min | Typ | Max | Units |
|-----------------------------|-------------------|---------------------|-----|-----|-----|-------|
| Under-voltage Lockout | V_{UVLO} | V_{IN} increasing | 1.3 | 1.7 | -- | V |
| Under-voltage Hysteresis | ΔV_{UVLO} | V_{IN} decreasing | -- | 0.1 | -- | V |
| Thermal Shutdown Protection | T_{SD} | | -- | 130 | -- | °C |
| Thermal Shutdown Hysteresis | ΔT_{SD} | | -- | 20 | -- | °C |

Note 1. Stresses beyond those listed under "Absolute Maximum Ratings" may cause permanent damage to the device.

These are stress ratings only, and functional operation of the device at these or any other conditions beyond those indicated in the operational sections of the specifications is not implied. Exposure to absolute maximum rating conditions for extended periods may affect device reliability.

Note 2. Devices are ESD sensitive. Handling precaution recommended. The human body model is a 100pF capacitor discharged through a 1.5kΩ resistor into input and output pins.

Note 3. The device is not guaranteed to function outside its operating conditions.

Note 4. The FLAG delay time is input voltage dependent, see "Typical Operating Characteristics" graph for further details.

Typical Operating Characteristics (U.U.T: RT9702ACB, unless otherwise indicated)

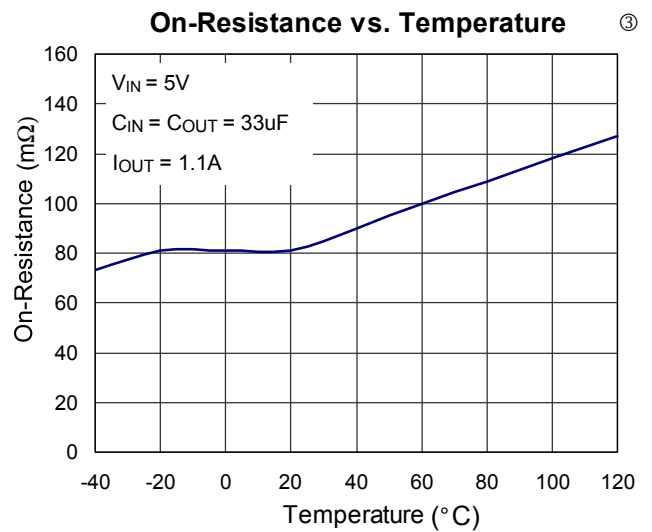
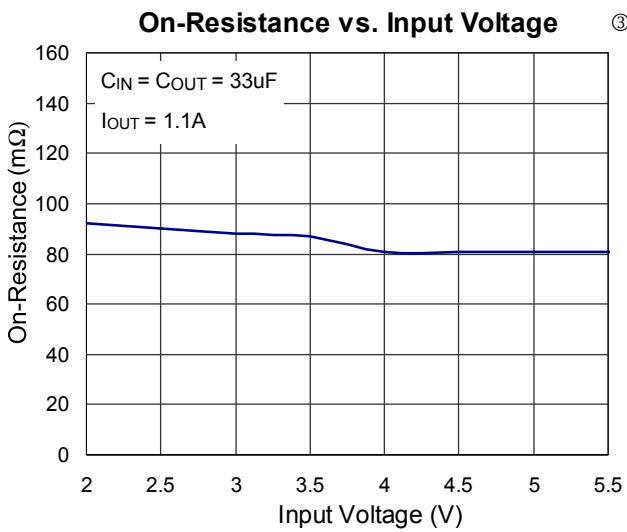
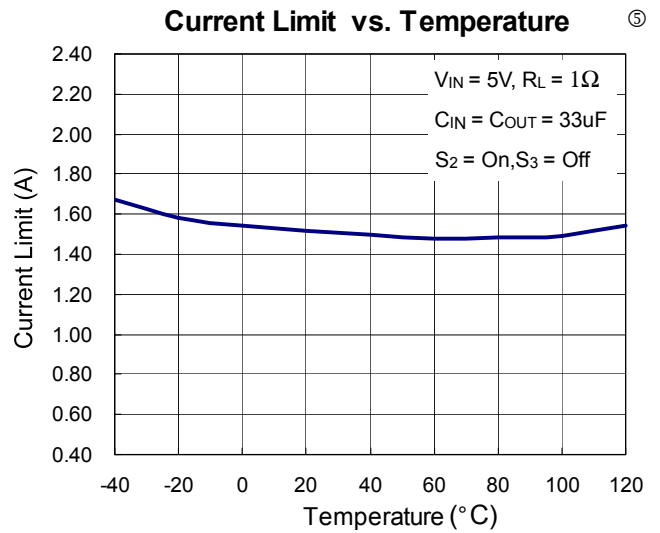
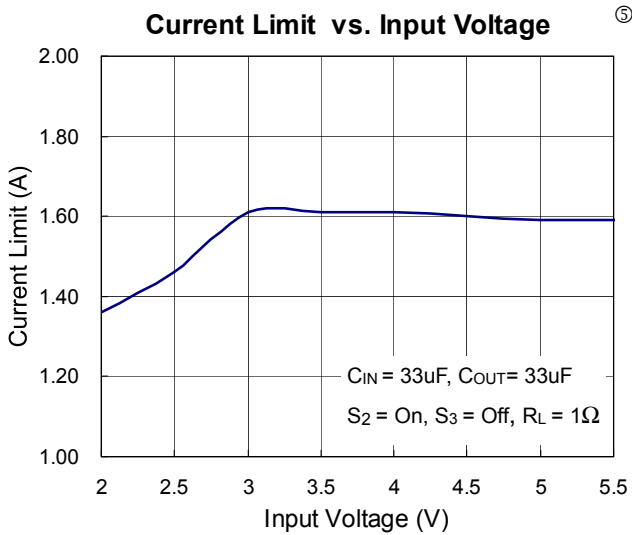
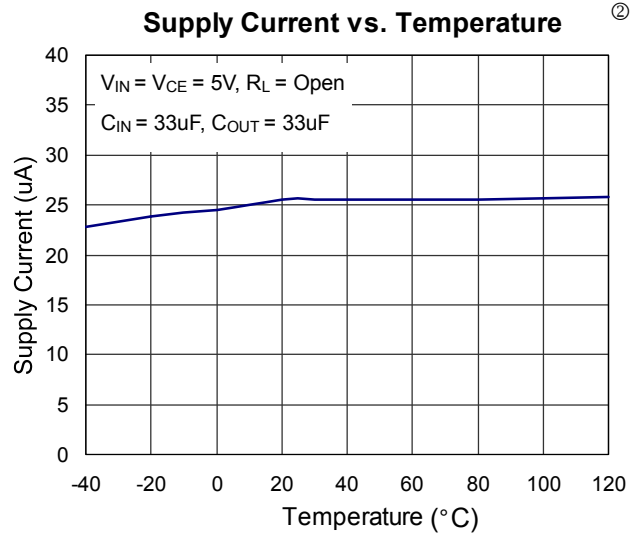
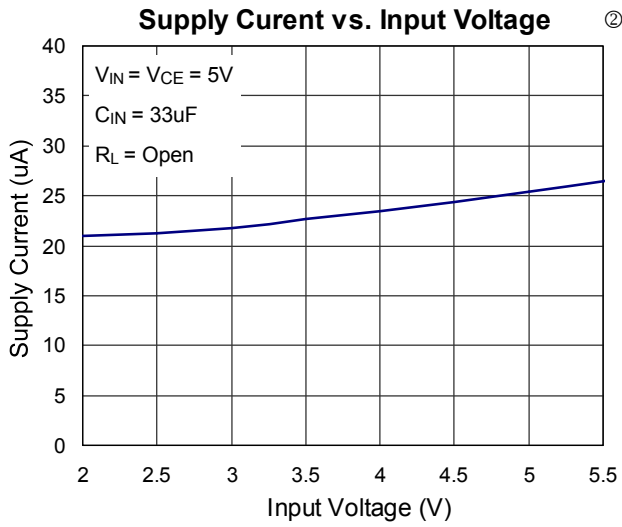

Short Circuit Current Response ⑤

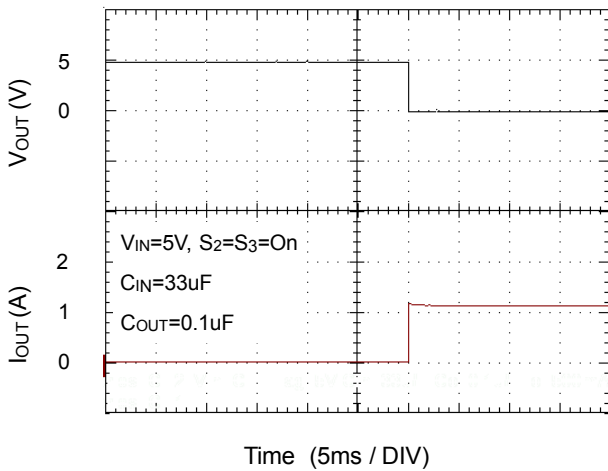

Short Circuit Current vs. Temperature ⑤

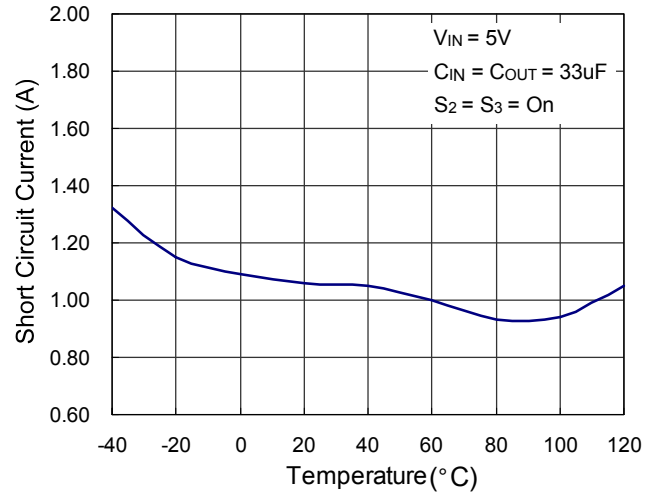

CE Threshold Voltage vs. Input Voltage ④

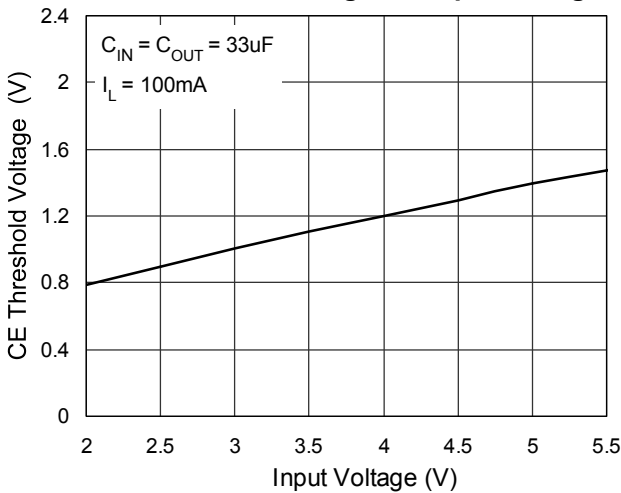

CE Threshold Voltage vs. Temperature ④

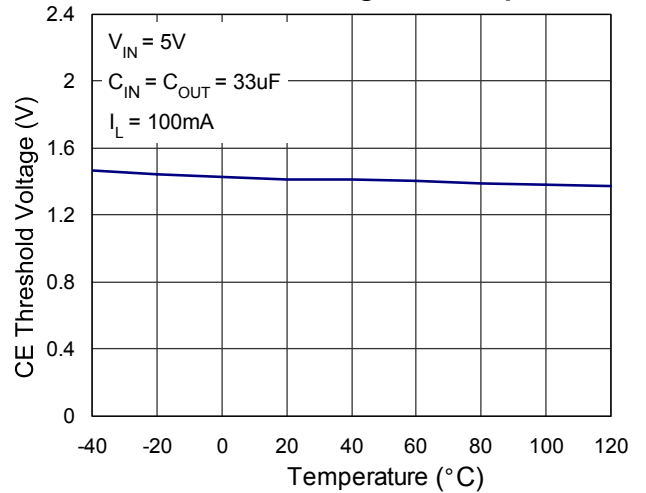

Turn-On Rising Time vs. Temperature ①

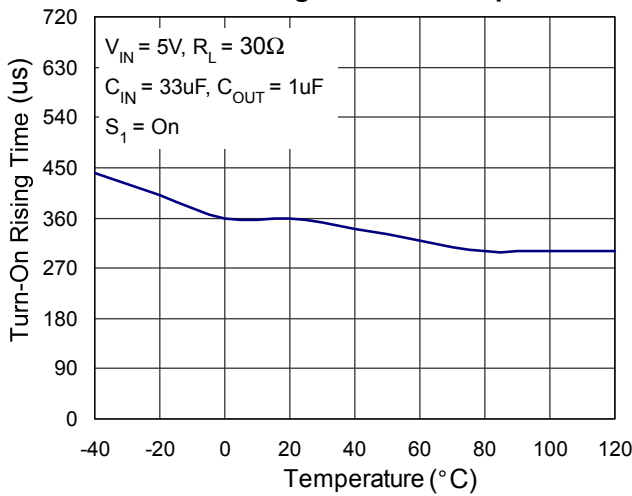

Turn-Off Falling Time vs. Temperature ①

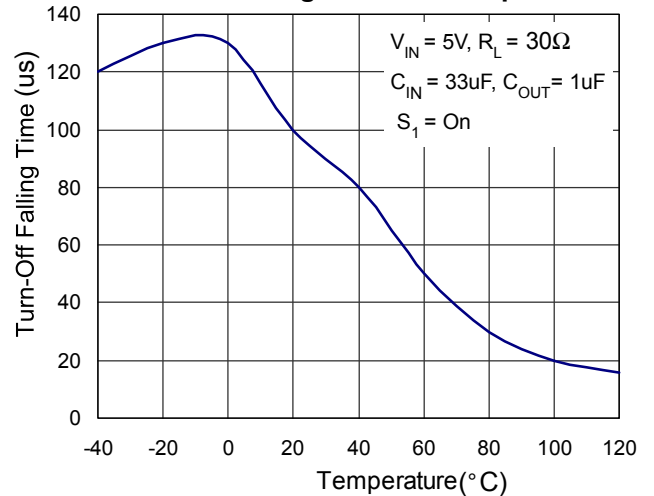

Switch Off Supply Current vs. Temperature

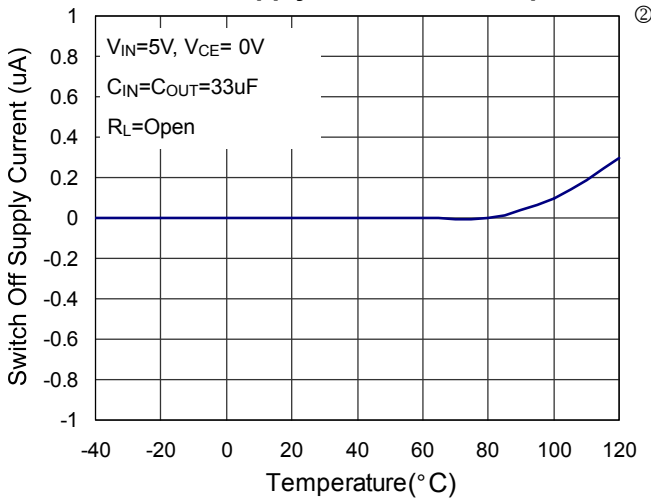

Turn-Off Leakage Current vs. Temperature

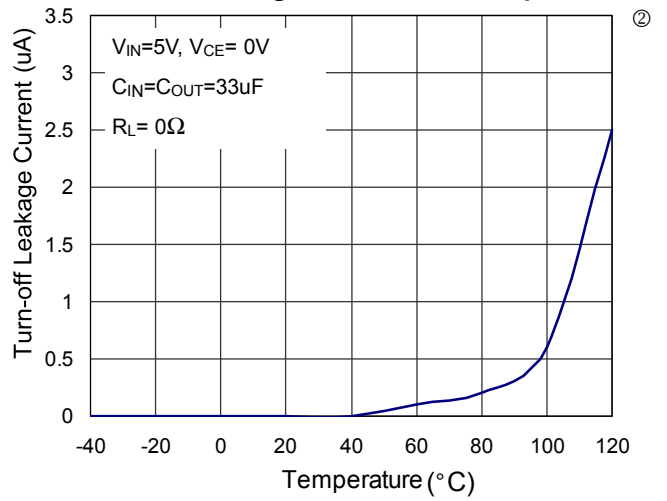

FLAG Delay Time vs. Input Voltage

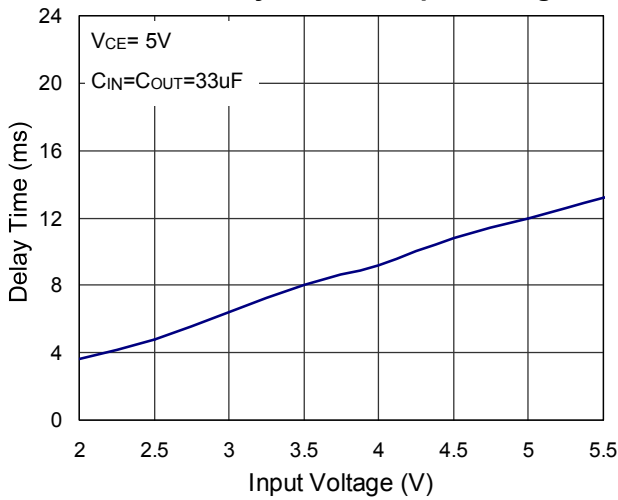

FLAG Delay Time vs. Temperature

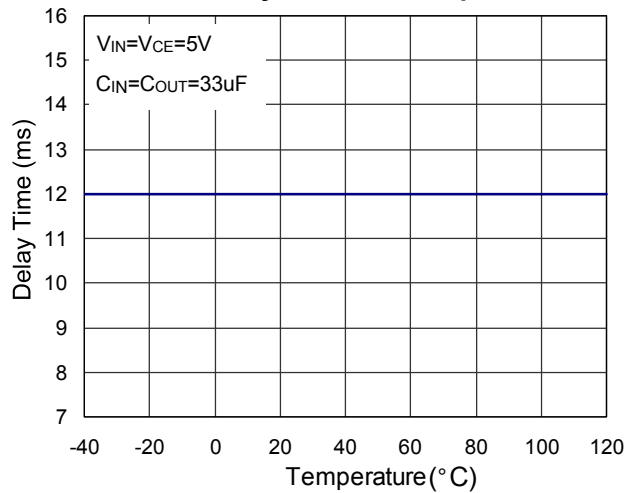

UVLO Threshold vs. Temperature

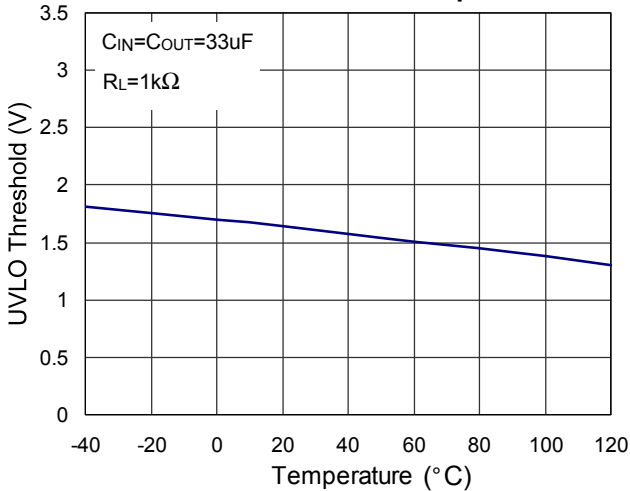

Short Circuit Current Response

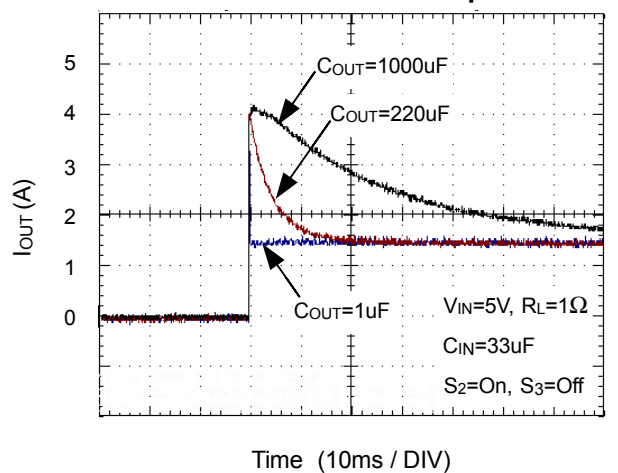

Turn-On Response ①

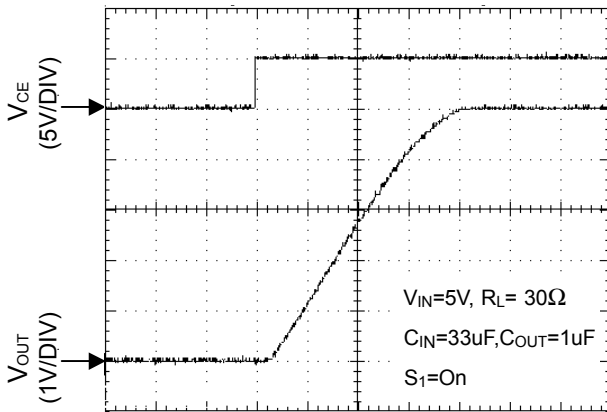

Time (100 μ s / DIV)

Turn-Off Response ①

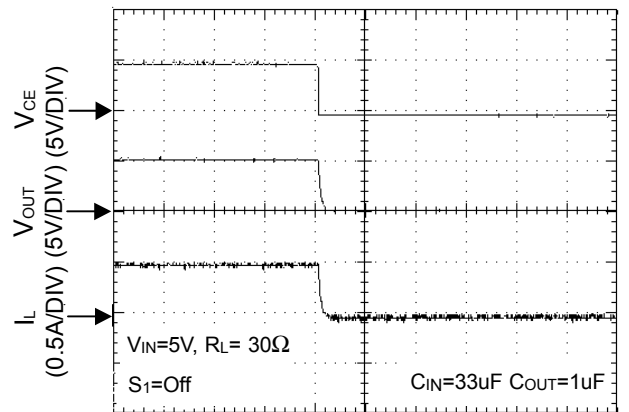

Time (100 μ s / DIV)

UVLO at Rising ④

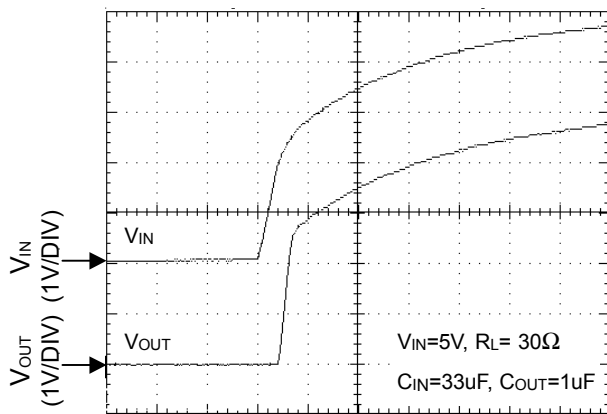

Time (1ms / DIV)

UVLO at Falling ④

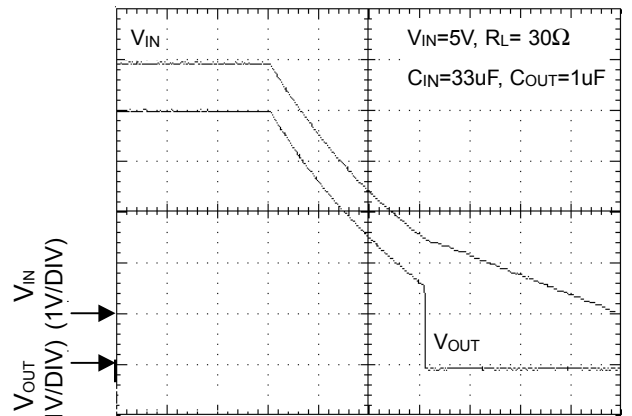

Time (10ms / DIV)

Soft-Start Response ⑤

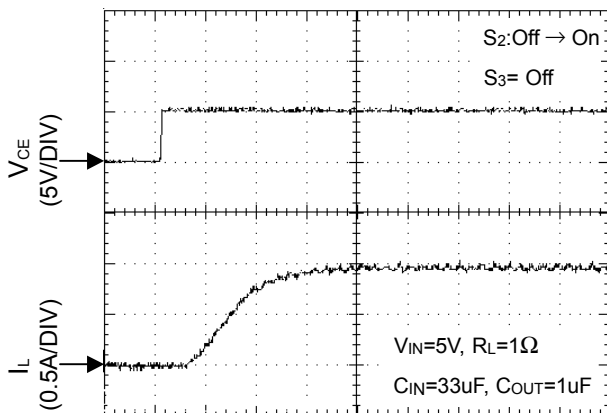

Time (50 μ s / DIV)

Ramped Load Response ⑤

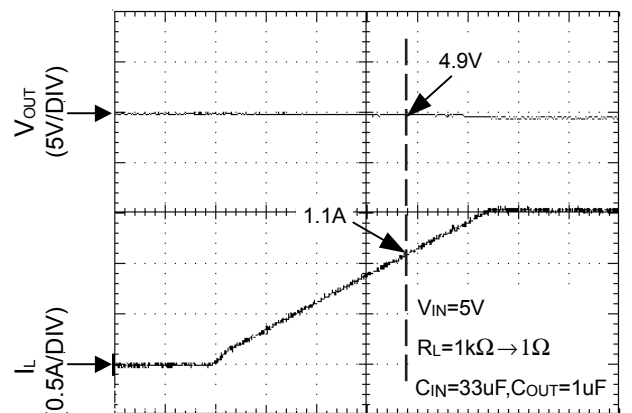

Time (100ms / DIV)

Flag Response (Enable into Short Circuit) ①

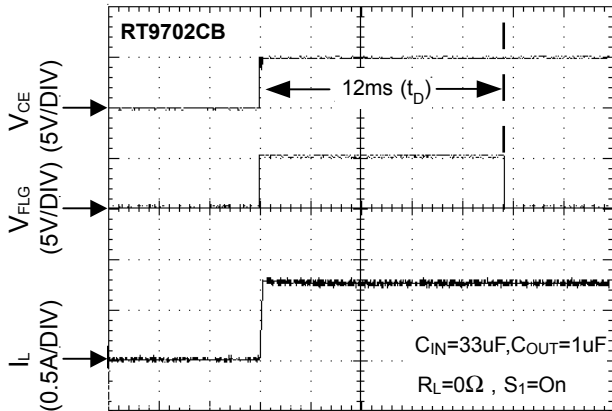

Time (2.5ms / DIV)

Flag Response ①

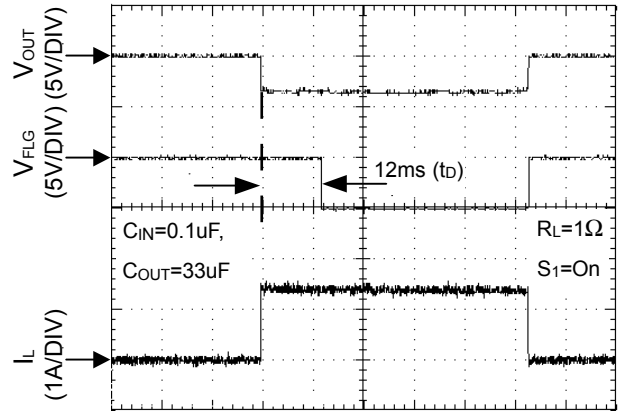

Time (10ms / DIV)

Current Limit Transient Responses ⑤

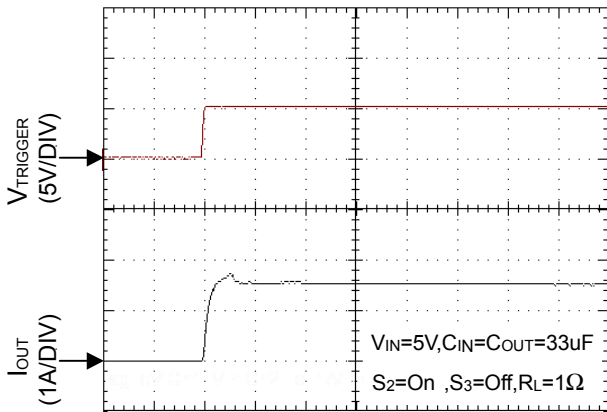

Time (5us / DIV)

Thermal Shutdown Response ⑤

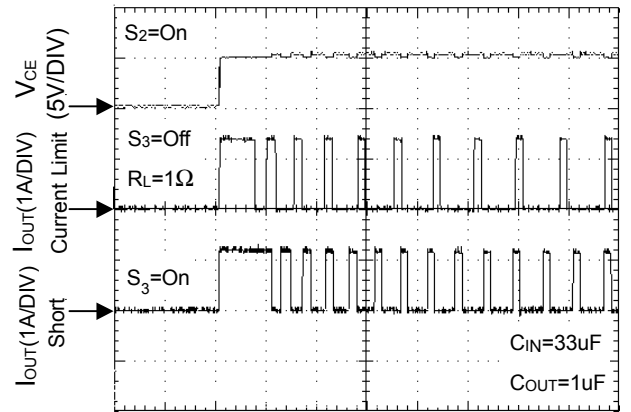

Time (50ms / DIV)

Applications Information

The RT9702 and RT9702A are single N-Channel MOSFET high-side power switches with active-high enable input, optimized for self-powered and bus-powered Universal Serial Bus (USB) applications. The RT9702/A equipped with a charge pump circuitry to drive the internal NMOS switch; the switch's low $R_{DS(ON)}$, 80m Ω , meets USB voltage drop requirements; and a flag output is available to indicate fault conditions to the local USB controller.

Input and Output

V_{IN} (input) is the power source connection to the internal circuitry and the drain of the MOSFET. V_{OUT} (output) is the source of the MOSFET. In a typical application, current flows through the switch from V_{IN} to V_{OUT} toward the load. If V_{OUT} is greater than V_{IN} , current will flow from V_{OUT} to V_{IN} since the MOSFET is bidirectional when on.

Unlike a normal MOSFET, there is no a parasitic body diode between drain and source of the MOSFET, the RT9702/A prevents reverse current flow if V_{OUT} being externally forced to a higher voltage than V_{IN} when the output disabled ($V_{CE} < 0.8V$).

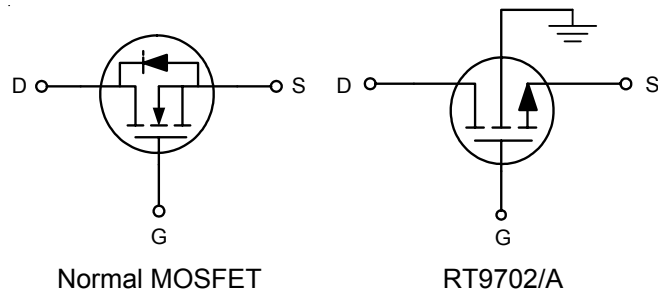

Chip Enable Input

The switch will be disabled when the CE pin is in a logic low condition. During this condition, the internal circuitry and MOSFET are turned off, reducing the supply current to 0.1 μ A Typical. The maximum guaranteed voltage for a logic low at the CE pin is 0.8V. A minimum guaranteed voltage of 2V at the CE pin will turn the RT9702/A back on. Floating the input may cause unpredictable operation. CE should not be allowed to go negative with respect to GND. The CE pin may be directly tied to V_{IN} to keep the part on.

Soft Start for Hot Plug-In Applications

In order to eliminate the upstream voltage droop caused by the large inrush current during hot-plug events, the "soft-start" feature effectively isolates the power source from extremely large capacitive loads, satisfying the USB voltage droop requirements.

Fault Flag

The RT9702/A provides a \overline{FLG} signal pin which is an N-Channel open drain MOSFET output. This open drain output goes low when $V_{OUT} < V_{IN} - 1V$, current limit or the die temperature exceeds 130 $^{\circ}$ C approximately. The \overline{FLG} output is capable of sinking a 10mA load to typically 200mV above ground. The \overline{FLG} pin requires a pull-up resistor, this resistor should be large in value to reduce energy drain. A 100k Ω pull-up resistor works well for most applications. In the case of an over-current condition, \overline{FLG} will be asserted only after the flag response delay time, t_D , has elapsed. This ensures that \overline{FLG} is asserted only upon valid over-current conditions and that erroneous error reporting is eliminated.

For example, false over-current conditions may occur during hot-plug events when extremely large capacitive loads are connected and causes a high transient inrush current that exceeds the current limit threshold. The \overline{FLG} response delay time t_D is typically 10ms.

Under-Voltage Lockout

Under-voltage lockout (UVLO) prevents the MOSFET switch from turning on until input voltage exceeds approximately 1.7V. If input voltage drops below approximately 1.3V, UVLO turns off the MOSFET switch, \overline{FLG} will be asserted accordingly. Under-voltage detection functions only when the switch is enabled.

Current Limiting and Short-Circuit Protection

The current limit circuitry prevents damage to the MOSFET switch and the hub downstream port but can deliver load current up to the current limit threshold of typically 800mA through the switch of RT9702 and 1.5A for RT9702A respectively. When a heavy load or short circuit is applied to an enabled switch, a large transient current may flow until the current limit circuitry responds.

Once this current limit threshold is exceeded the device enters constant current mode until the thermal shutdown occurs or the fault is removed.

Thermal Shutdown

Thermal shutdown is employed to protect the device from damage if the die temperature exceeds approximately 130°C. If enabled, the switch automatically restarts when the die temperature falls 20°C. The output and FLG signal will continue to cycle on and off until the device is disabled or the fault is removed.

Power Dissipation

The device's junction temperature depends on several factors such as the load, PCB layout, ambient temperature and package type. The output pin of RT9702/A can deliver a current of up to 500mA, and 1.1A respectively over the full operating junction temperature range. However, the maximum output current must be derated at higher ambient temperature to ensure the junction temperature does not exceed 100°C. With all possible conditions, the junction temperature must be within the range specified under operating conditions. Power dissipation can be calculated based on the output current and the $R_{DS(ON)}$ of switch as below.

$$P_D = R_{DS(ON)} \times I_{OUT}^2$$

Although the devices are rated for 500mA and 1.1A of output current, but the application may limit the amount of output current based on the total power dissipation and the ambient temperature. The final operating junction temperature for any set of conditions can be estimated by the following thermal equation:

$$P_{D(MAX)} = (T_{J(MAX)} - T_A) / \theta_{JA}$$

Where $T_{J(MAX)}$ is the maximum junction temperature of the die (100°C) and T_A is the maximum ambient temperature. The junction to ambient thermal resistance (θ_{JA}) for SOT-25 package at recommended minimum footprint is 250°C/W (θ_{JA} is layout dependent).

Universal Serial Bus (USB) & Power Distribution

The goal of USB is to be enabled device from different vendors to interoperate in an open architecture. USB features include ease of use for the end user, a wide range

of workloads and applications, robustness, synergy with the PC industry, and low-cost implementation. Benefits include self-identifying peripherals, dynamically attachable and reconfigurable peripherals, multiple connections (support for concurrent operation of many devices), support for as many as 127 physical devices, and compatibility with PC Plug-and-Play architecture.

The Universal Serial Bus connects USB devices with a USB host: each USB system has one USB host. USB devices are classified either as hubs, which provide additional attachment points to the USB, or as functions, which provide capabilities to the system (for example, a digital joystick). Hub devices are then classified as either Bus-Powered Hubs or Self-Powered Hubs.

A Bus-Powered Hub draws all of the power to any internal functions and downstream ports from the USB connector power pins. The hub may draw up to 500mA from the upstream device. External ports in a Bus-Powered Hub can supply up to 100mA per port, with a maximum of four external ports.

Self-Powered Hub power for the internal functions and downstream ports does not come from the USB, although the USB interface may draw up to 100mA from its upstream connect, to allow the interface to function when the remainder of the hub is powered down. The hub must be able to supply up to 500mA on all of its external downstream ports. Please refer to Universal Serial Specification Revision 2.0 for more details on designing compliant USB hub and host systems.

Over-Current protection devices such as fuses and PTC resistors (also called polyfuse or polyswitch) have slow trip times, high on-resistance, and lack the necessary circuitry for USB-required fault reporting.

The faster trip time of the RT9702/A power distribution allow designers to design hubs that can operate through faults. The RT9702/A have low on-resistance and internal fault-reporting circuitry that help the designer to meet voltage regulation and fault notification requirements.

Because the devices are also power switches, the designer of self-powered hubs has the flexibility to turn off power to output ports. Unlike a normal MOSFET, the devices have controlled rise and fall times to provide the needed inrush current limiting required for the bus-powered hub power switch.

Supply Filter/Bypass Capacitor

A 1μF low-ESR ceramic capacitor from V_{IN} to GND, located at the device is strongly recommended to prevent the input voltage drooping during hot-plug events. However, higher capacitor values will further reduce the voltage droop on the input. Furthermore, without the bypass capacitor, an output short may cause sufficient ringing on the input (from source lead inductance) to destroy the internal control circuitry. The input transient must not exceed 6.5V of the absolute maximum supply voltage even for a short duration.

Output Filter Capacitor

A low-ESR 150μF aluminum electrolytic or tantalum between V_{OUT} and GND is strongly recommended to meet the 330mV maximum droop requirement in the hub V_{BUS} (Per USB 2.0, output ports must have a minimum 120μF of low-ESR bulk capacitance per hub). Standard bypass methods should be used to minimize inductance and resistance between the bypass capacitor and the downstream connector to reduce EMI and decouple voltage droop caused when downstream cables are hot-insertion transients. Ferrite beads in series with V_{BUS} , the ground line and the 0.1μF bypass capacitors at the power connector pins are recommended for EMI and ESD protection. The bypass capacitor itself should have a low dissipation factor to allow decoupling at higher frequencies.

Fault Flag Filtering (Optional)

The transient inrush current to downstream capacitance may cause a short-duration error flag, which may cause erroneous over-current reporting. A simple 1ms RC low-pass filter (10KΩ and 0.1μF) in the flag line (see Typical Application Circuit) eliminates short-duration transients.

Voltage Drop

The USB specification states a minimum port-output voltage in two locations on the bus, 4.75V out of a Self-Powered Hub port and 4.40V out of a Bus-Powered Hub port. As with the Self-Powered Hub, all resistive voltage drops for the Bus-Powered Hub must be accounted for to guarantee voltage regulation (see Figure 7-47 of Universal Serial Specification Revision 2.0).

The following calculation determines $V_{OUT(MIN)}$ for multiple ports (N_{PORTS}) ganged together through one switch (if using one switch per port, N_{PORTS} is equal to 1):

$$V_{OUT(MIN)} = 4.75V - [I_I \times (4 \cdot R_{CONN} + 2 \cdot R_{CABLE})] - (0.1A \times N_{PORTS} \times R_{SWITCH}) - V_{PCB}$$

Where

R_{CONN} = Resistance of connector contacts
(two contacts per connector)

R_{CABLE} = Resistance of upstream cable wires
(one 5V and one GND)

R_{SWITCH} = Resistance of power switch
(80mΩ typical for RT9702/A)

V_{PCB} = PCB voltage drop

The USB specification defines the maximum resistance per contact (R_{CONN}) of the USB connector to be 30mΩ and the drop across the PCB and switch to be 100mV. This basically leaves two variables in the equation: the resistance of the switch and the resistance of the cable.

If the hub consumes the maximum current (I_I) of 500mA, the maximum resistance of the cable is 90mΩ.

The resistance of the switch is defined as follows:

$$R_{SWITCH} = \{ 4.75V - 4.4V - [0.5A \times (4 \cdot 30m\Omega + 2 \cdot 90m\Omega)] - V_{PCB} \} \div (0.1A \times N_{PORTS})$$

$$= (200mV - V_{PCB}) \div (0.1A \times N_{PORTS})$$

If the voltage drop across the PCB is limited to 100mV, the maximum resistance for the switch is 250mΩ for four ports ganged together. The RT9702/A, with its maximum 100mΩ on-resistance over temperature, easily meets this requirement.

PCB Layout

In order to meet the voltage drop, droop, and EMI requirements, careful PCB layout is necessary. The following guidelines must be considered:

- Keep all V_{BUS} traces as short as possible and use at least 50-mil, 2 ounce copper for all V_{BUS} traces.
- Avoid vias as much as possible. If vias are necessary, make them as large as feasible.
- Place a ground plane under all circuitry to lower both resistance and inductance and improve DC and transient performance (Use a separate ground and power plans if possible).
- Place cuts in the ground plane between ports to help reduce the coupling of transients between ports.
- Locate the output capacitor and ferrite beads as close to the USB connectors as possible to lower impedance (mainly inductance) between the port and the capacitor and improve transient load performance.
- Locate the RT9702/A as close as possible to the output port to limit switching noise.
- Locate the ceramic bypass capacitors as close as possible to the V_{IN} pins of the RT9702/A.

ESD

Because USB is a hot insertion and removal system, USB components (especially the connector pins) are subject to electrostatic discharge (ESD) and should be qualified to IEC801.2. The RT9702/A is designed to withstand a 8kV human body mode, as defined in MIL-STD-883C. The requirements in IEC801.2 are much more stringent and require additional capacitors for the RT9702/A to withstand the higher ESD energy.

Low-ESR $1\mu\text{F}$ ceramic bypass capacitors and output capacitors should be placed as closely as possible to the V_{IN} and V_{OUT} pins to increase the ESD immunity. The RT9702/A may pass the requirements of IEC 1000-4-2 (EN 50082-1) level-4 for 15kV air discharge and 8kV contact discharge tests when these capacitors are added.

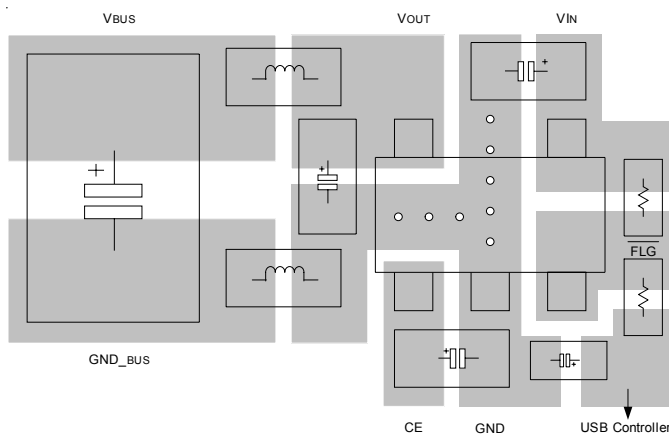

Board Layout

Outline Dimension

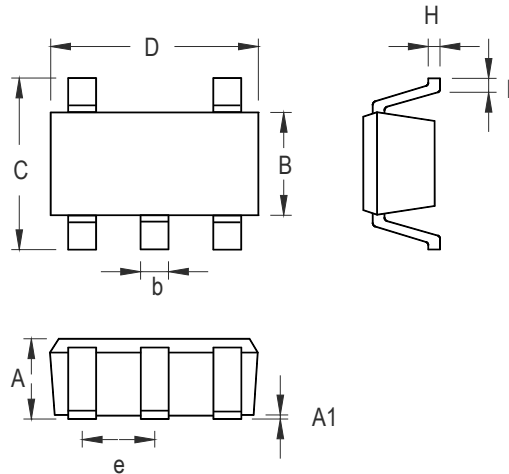

| Symbol | Dimensions In Millimeters | | Dimensions In Inches | |
|--------|---------------------------|-------|----------------------|-------|
| | Min | Max | Min | Max |
| A | 0.889 | 1.295 | 0.035 | 0.051 |
| A1 | 0.000 | 0.152 | 0.000 | 0.006 |
| B | 1.397 | 1.803 | 0.055 | 0.071 |
| b | 0.356 | 0.559 | 0.014 | 0.022 |
| C | 2.591 | 2.997 | 0.102 | 0.118 |
| D | 2.692 | 3.099 | 0.106 | 0.122 |
| e | 0.838 | 1.041 | 0.033 | 0.041 |
| H | 0.080 | 0.254 | 0.003 | 0.010 |
| L | 0.300 | 0.610 | 0.012 | 0.024 |

SOT- 25 Surface Mount Package

RICHTEK TECHNOLOGY CORP.

Headquarter

5F, No. 20, Taiyuen Street, Chupei City

Hsinchu, Taiwan, R.O.C.

Tel: (8863)5526789 Fax: (8863)5526611

RICHTEK TECHNOLOGY CORP.

Taipei Office (Marketing)

8F-1, No. 137, Lane 235, Paochiao Road, Hsintien City

Taipei County, Taiwan, R.O.C.

Tel: (8862)89191466 Fax: (8862)89191465

Email: marketing@richtek.com